

Sollatek



Voltshield™

The Sollatek Switcher Range

Instruction manual



AVS 13/15 MICRO



AVS 13RL MICRO



AVS30 MICRO



AVS100



AVS3P-0



AVS303

Important: This manual contains important safety instructions.
Keep this manual handy for reference.

INTRODUCTION

Without doubt, power interruptions cause major problems for home and business computing. An unpredictable power supply can lead to worrying problems such as surges, spikes, lightning strikes, brown-outs, power-cuts (black-outs), power-back surges, mains over-voltage, and complete failure - all of which can damage electrical and electronic equipment. If any of these should occur, there's a strong chance you will suffer from loss of critical data, lowered productivity and even damage to your expensive equipment.

Sollatek encompasses a wide range of power protection products for use in many different industries where clean, regulated mains power is critical to their continued operation.

For more information on our range of power protection products, contact us now.

THE SOLLATEK AUTOMATIC VOLTAGE SWITCHER (AVS) RANGE

The Sollatek Voltshield (AVS) range prevents damage to equipment from over and under voltage levels of any duration. They work by disconnecting power when voltage levels exceed set parameters. Reconnection takes place when power returns to normal.

Fully automatic in operation. All these products provide power-back surge protection as standard by their in-built start-up delay and voltage monitoring.

Additionally, all models include surge and spike protection.

Contents

The Sollatek AVS13/13RL/15 micro	p.4-5
The Sollatek AVS30 micro	p.6-9
The Sollatek AVS100	p.10-11
The Sollatek AVS3P-0	p.12-13
The Sollatek AVS303	p.14-15
Comparison chart	p.16-17
Power problems	p.18-19

AVS13 micro, AVS13 RL micro, AVS15 micro



The AVS is an Automatic Voltage Switcher rated at 13 Amps (AVS13) or 15Amps (AVS15). The AVS will switch off the equipment connected to it if the mains power goes outside preset acceptable limits and will re-connect -automatically* - when the mains power returns to normal. Re-connection takes place after a delay to ensure stability of the mains.

This new version of the AVS has a built-in micro-processor that has added advanced features to the product. These include;

1) Five voltage indicators

✓ The power supply is good and the load is connected

Hi The AVS has detected that the mains voltage is too high and therefore dangerous to your equipment. The AVS has disconnected the power supply .

⌚ Power supply has returned to normal (after an over-voltage condition - see above). The AVS is waiting before the power supply is restored to your equipment.

⌚ Power supply has returned to normal (after an under-voltage condition - see below). The AVS is waiting before the power supply is restored to your equipment.

Lo The AVS has detected low voltage condition and has disconnected the power to your equipment to protect against it.

** unless set to MANUAL on the Time delay Dial*

2) Time Delay dial

By adjusting the dial, you can set the start-up delay (after first connecting and after re-connection in case of over or under-voltage) from 15 Seconds to 3 minutes (AVS13) or 1.5 minute to 5 minutes (AVS15). Alternatively you can pre-set to MANUAL. MANUAL indicates that the AVS will not connect your load until you press the LOAD ON/OFF switch.

Tip: Use MANUAL setting if you do not want equipment to automatically re-start for example if you do not wish the Air-conditioner to re-connect automatically after a power cut.

3) LOAD ON/OFF Switch

Using this button,  you can switch your equipment on or off. If the switch is in the off position (Light bulb off), press the switch to turn the equipment on. PLEASE NOTE THAT THE EQUIPMENT WILL BE CONNECTED AFTER THE DELAY HAS PASSED AS SET BY THE TIME DELAY DIAL.

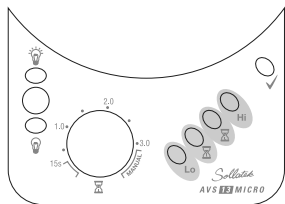

SPECIFICATIONS

Model	AVS13	AVS13RL	AVS15
Current (Amps)	13	13	15
Nominal voltage(V)	230	230	230
Wait time (mins)	adjustable 15 secs-3mins	adjustable 15 secs-3mins	adjustable 1.5mins-5mins
Under-voltage disconnect(V)	185	185	185
Over-voltage disconnect(V)	260	260	260
Hysteresis(V)	3-7	3-7	3-7
Socket type	UK13A (BS1363)	UK13A (BS1363)	UK15A unfused plug
Fused plug	Yes. 13Amp	Yes. 13Amp	No
RFI protection	No	Yes	No
Attenuation(db)	N/A	20@100Khz,50@1Mhz 35@10Mhz	N/A
Transient suppression	Yes(>6.5kA)	Yes(>6.5kA)	Yes(>6.5kA)
Spike protection(J)	160	160	160

OPERATION:

1. Make sure that your load does not exceed the rating of the AVS.
2. The limits of the AVS are pre-set at the factory (i.e. The AVS13 is 185-260 volts).
If different limits are required, please refer to your dealer.
3. Plug your appliance into the AVS.
4. The LEDs on the front indicate the state of the AVS (see facing page for full details).
5. It is recommended that the AVS is kept switched on, and the appliance switched on and off to prevent activating the time delay every time the appliance is switched on.
6. The plug connected to the AVS13 is fused at 13Amps. If the unit stops working and no LEDs are lit on the front of the unit check that the fuse is intact. If not, replace with a 13Amp HBC fuse.

Caution: Before replacing fuse or resetting the circuit breaker, ensure that the load does not exceed the recommended rating of the AVS.



AVS30 micro

The AVS30 micro is a single phase Automatic Voltage Switcher rated at 30 Amps. The AVS will switch off the equipment connected to it if the mains power goes outside pre-set acceptable limits, and will reconnect automatically when the mains power returns to normal. Reconnection takes place after a delay, to ensure stability of the mains.

The new version of the AVS has a built-in microprocessor that adds advanced features. These include:

Five LEDs accurately display the status of the AVS in the following symmetrical traffic light design:



LED Colour	Indicating	Load Status
Red	High incoming voltage	OFF
Yellow	AVS is in wait state after a high voltage transition	OFF
Green	Mains normal	ON
Yellow	AVS is in wait state after a low voltage transition	OFF
Red	Low incoming voltage	OFF

By adding microprocessor control to the AVS30, you can enjoy advanced functions which include:

- * Variable time delay
- * Variable Low voltage disconnect level
- * Variable High voltage disconnect level
- * Variable Blind time. Response time to under voltage disconnect
- * Intelligent time delay

All these new features can be set at installation time.

- * The AVS30 Micro has a reset button on the front panel. This button will eliminate the delay time.
- * 5 LEDs to indicate the state of the mains supply.

OPERATION

1. Make sure that your load does not exceed the rating of the AVS which is 30Amps.
2. The limits of the AVS as a standard are set for a window of 190-260 volts.
3. The AVS has to be wired to the mains supply and to the equipment it is supplying.
Please refer to the wiring diagram on page 9.
4. On first switching on, there will be no output for the wait time of approximately three minutes while the AVS monitors the mains.
 - a) To by-pass the wait time, press the re-set button on the front panel of the AVS30.
 - b) If a different wait time is required, then change the settings on potentiometer marked WAIT. Settings are available in increments up to 10 minutes.
You can also set the WAIT dial to MAN. While on MAN the AVS30 will not reconnect the mains unless the Reset button is pressed. For that period the yellow LED indicates that the mains are within acceptable limits, after which the green LED goes on and the load is connected.
5. A different blind time can be set if a different undervoltage disconnect limit is required.
Under voltage blind time means the AVS ignores any undervoltage conditions during this time. The AVS will not switch off unless the under voltage last longer than the blind time.
6. It is recommended that the AVS is kept switched on, and the appliance switched on and off to prevent activating the time delay every time the appliance is switched on.

SPECIFICATIONS

Model AVS30micro	110V	230V
Current (Amps)	30	30
Nominal voltage(V)	110	230
Wait time (mins)	10 secs to 10mins+manual	10 secs to 10mins+manual
Under-voltage disconnect(V)	75-110	150-230
Over-voltage disconnect(V)	110-150+off	230-300+off
Hysteresis(V)	3-5	3-5
Socket type	direct via brass screw terminal	direct via brass screw terminal
Fused plug	N/A	N/A
RFI protection	No	No
Transient suppression	Yes >6.5kA	Yes >6.5kA
Spike protection(J)	80	160

CONNECTION:

CAUTION: IF THE AVS IS ALREADY WIRED, MAKE SURE IT IS DISCONNECTED FROM THE MAINS BEFORE YOU DO ANY OF THE FOLLOWING;

1. Remove the bottom cover to obtain access to connection terminals. To remove bottom cover remove the two white caps and then undo the two screws.
2. Remove the two cable glands and then re-insert them so that the cable gland is external.
3. Insert cable from the mains supply through the cable glands of the AVS30 and connect to the Connector terminals. (Refer to connection terminals layout diagram on next page).
4. Insert cable to appliance through the Cordgrip Bush and connect to the Connector terminals
5. Tighten the Cordgrip Bushes and return the front cover and two screws and screw caps.

PLEASE ENSURE NOT TO TIGHTEN CONNECTION TERMINALS EXCESSIVELY.

NOTES:

- * In the upper compartment of the AVS, you will find a fuse (see diagram overleaf). The fuse is not for the load. It is a spike protection fuse. Replace if it gets damaged. (0.5A Anti Surge). To gain access to the upper compartment, ENSURE THAT THE AVS30 IS NOT CONNECTED TO THE MAINS. Remove the screws from the back.
- * The AVS must be mounted securely on a wall. Place it over one screw at the top and then use the two mounting holes in the terminal compartment.
- * The supply to the AVS30 must be fitted with a 30A HBC fuse or less.

AVS30 CONNECTION TERMINALS LAYOUT

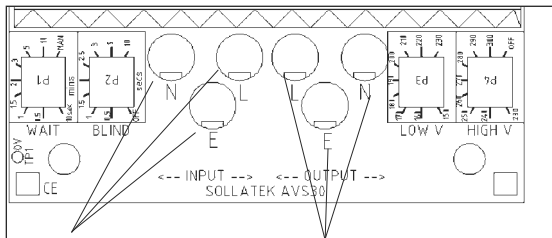

AVS30 INPUT

L (Live) to L
 N (Neutral) to N
 E (Earth) to E

AVS30 OUTPUT

L (Live) to L out
 N (Neutral) to N out
 E (Earth) to E out if used

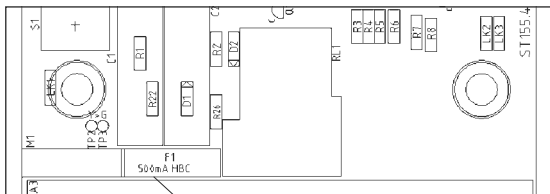



AVS100

The AVS100 is a single phase Automatic Voltage Switcher rated at 100 Amps. If the voltage goes above or below the pre-set limits (the 'window'), then the AVS100 will switch off. Once the voltage returns within the window limits, the AVS will wait for a pre-set time, continuing to check the voltages, before automatically turning the load back on.

OPERATION

1. Make sure that your load does not exceed the rating of the AVS (100 Amps for the AVS100).
2. The limits of the AVS are set for a window of 190-260 volts. If a different window is required, please refer to your dealer.
3. The AVS has to be wired to the mains supply and to the equipment it is supplying. Please refer to the wiring diagram on page 11.
4. On first switching on, there will be no output for the wait time of approximately three minutes while the AVS monitors the mains voltage. If a different wait time is required, please refer to your dealer. For that period the yellow LED indicates that the mains are within acceptable limits, after which the green LED goes on and the load is connected. The red LED indicates that the mains supply is outside the window, and the load is disconnected.
5. It is recommended that the AVS is kept switched on, and the appliance switched on and off to prevent activating the time delay every time the appliance is switched on.

SPECIFICATIONS

Model AVS100	110V	230V
Current (Amps)	100	100
Nominal voltage(V)	110	230
Wait time (mins)	3 mins	3 mins
Under-voltage disconnect(V)	75-110	150-230
Over-voltage disconnect(V)	110-150+off	230-300+off
Hysteresis(V)	3-5V	3-5V
Connection	screw terminals	screw terminals
Fused plug	N/A	N/A
RFI protection	No	No
Transient suppression	Yes >6.5kA	Yes >6.5kA
Spike protection(J)	80	160

CONNECTION:

CAUTION: IF THE AVS IS ALREADY WIRED, MAKE SURE IT IS DISCONNECTED FROM THE MAINS BEFORE YOU DO ANY OF THE FOLLOWING;

1. Open the door to obtain access to connection terminals.
2. Insert cable from the mains supply through the cable entry at the top of the box.

AVS100 INPUT

L (Live) to Terminal L1 of Contactor
N (Neutral) to Neutral IN terminal block
E (Earth) to Earth IN terminal block

3. Insert cable to appliance through cable entry at bottom of box.

AVS100 OUTPUT

L (Live) to Terminal T1 of Contactor
N (Neutral) to Neutral OUT terminal block
E (Earth) to Earth OUT terminal block

4. Ensure connections are secure and close door.

NOTES:

- * The fuse in the terminal compartment is not for the load. It is a spike protection fuse.
To replace, use a 0.5A HBC type anti-surge 20x5mm fuse.
- * The AVS should be mounted securely on a wall.
- * The supply to the AVS100 must be fitted with a 100A fuse or less.

AVS100 CONNECTION DIAGRAM

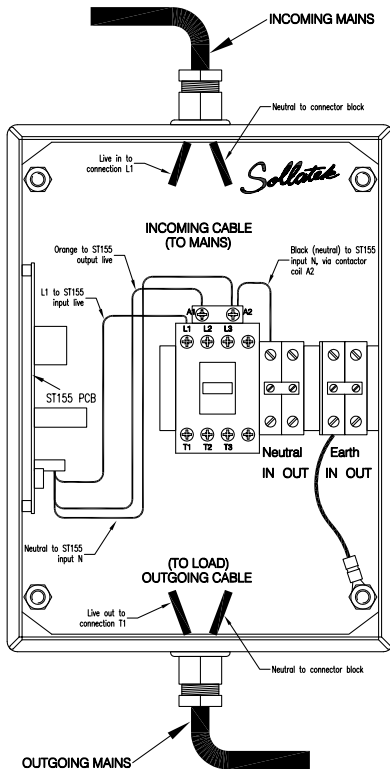



AVS3P-0

The AVS3P-0 is an Automatic Voltage Switcher designed to protect three phase loads from voltage fluctuations, over voltage, under voltage, surges, dips and frequent start/stops. The output is a single volt-free changeover contact, rated at 16A. This is intended to control an external contactor, control circuit, start/stop system or alarm. If the voltage on any one phase goes above or below the pre-set limits (the 'window'), then the AVS will switch off. Once the voltage returns within the window limits, the AVS will wait for a pre-set time, continuing to check the voltages, before automatically turning the load back on. The over voltage, under voltage and

delay settings are all adjustable using controls in the terminal compartment of the AVS3P. The standard window that is considered acceptable is 185V-260V(320V-450V three phase). Outside these limits electronic and electrical equipment are likely to be damaged.

Five LEDs accurately display the status of the AVS in the following symmetrical traffic light design:

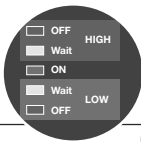

LED Colour	Indicating	Load Status
Red	High incoming voltage	OFF
Yellow	AVS is in wait state after a high voltage transition	OFF
Green	Mains normal	ON
Yellow	AVS is in wait state after a low voltage transition	OFF
Red	Low incoming voltage	OFF

OPERATION

1. Connect the AVS in accordance with the wiring diagram opposite (fig 1). Ensure that the R, S & T sensing connections to the AVS come from the supply side of the contactor. Note: a good neutral connection must be provided from the supply.
2. The output from the AVS is a changeover relay with volt-free contacts. There is a common (C), a normally open (NO) and normally closed (NC) contacts. When the AVS3P-0 is in the Red or Amber condition then C is connected to NC. When the AVS3P-0 displays Green then C is connected to NO. Make sure that the control current you wish to switch does not exceed the rating of the AVS3P-0 relay (max 16Amps).
3. If the AVS is the only thing to control the contactor (or load, or alarm, etc), then the 'C' and 'NO' AVS contacts can be used to connect power to the contactor coil (method A). If however, there are other circuits/equipment that also must control the contactor, then the AVS contacts can be used to interrupt the contactor coil supply from there (method B) or used in conjunction with a start/stop or other system, e.g. method C.

- Set limits of the AVS3P-0 using the thumb-wheel adjustment inside the terminal compartment. Ensure that limits set are safe for the load being protected. For example: Low =185V and High = 260V is normally considered safe for most equipment but you should check with the equipment manufacturer's information.
- Set the time delay control using the thumb-wheel adjustment inside the terminal compartment. This will depend on your load and how it is operated. As a general guide, compressors and refrigeration equipment will need at least 3 minutes; motors, pumps, etc should not be started too frequently so may be 2 minutes minimum, electronic loads 0.5 minutes. The 'Off' position gives just 10 seconds. The equipment manufacturer should be consulted on the best setting.
- At first switching on, there will be no output during the Delay period. For that period the yellow LED indicates that the mains supply is within acceptable limits, after which the green LED goes on and the output relay changes state to turn the load on.

SPECIFICATIONS

Model AVS3P-0	115V	240V
Current (Amps)	16A@230V	16A@230V
Nominal voltage(V)	115/127V	230/240V
Wait time (mins)	10 secs to 10mins	10 secs to 10mins
Window limits	adjustable	adjustable
Hysteresis(V)	2	4
Socket type	direct via brass screw terminal	
Fused plug	N/A	N/A
Transient suppression	Yes	Yes
Spike protection(J)	80J@115V	160J@230V
Max supply (phase to neutral)	160V	320V

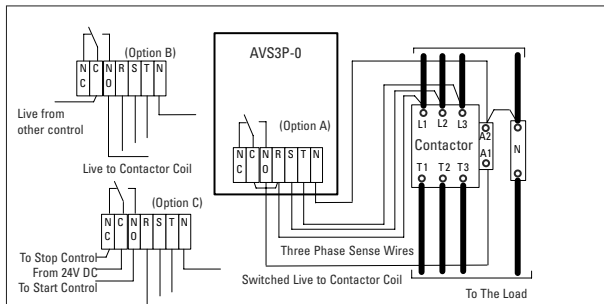

Figure 1.
AVS3P-0
wiring diagram



AVS303

The AVS303 is a Three Phase Automatic Voltage Switcher which protects against over voltage and under voltage on any one of the three phases as well as loss of one or more phases. Indication and/or disconnection as a result of mains frequency error or phase sequence error is available as an option.

The AVS303 incorporates a contactor to switch the full load current. The AVS303-xx is available in different sizes ranging from 23Amps to 1250Amps (the -xx relates to the model number, ie: AVS303-23 is a 23Amp per phase AVS303).

The options for the AVS303 are:

Frequency error (OPT/01)

Phase sequence error (OPT/02)

Or both (OPT/03)

If using the 'R' firmware option which provides Phase Rotation Error, it may be necessary to swap any two of the incoming phase connections to obtain the desired phase order.

OPERATION

1. Make sure that your load does not exceed the rating of the AVS303.
2. The limits of the AVS303 are set for a window of 190-260 volts line to neutral. If a different window is required, please refer to your dealer.
3. Connections of the three phases from the mains (INCOMING CABLE) and to the load (OUTGOING CABLE) are made to the contactor. It is essential that the incoming NEUTRAL is connected to the terminal block.
4. On first switching on, there will be no output for approximately one minute while the AVS303 monitors the mains. For that period the yellow LED indicates that the mains are within acceptable limits, after which the green LED goes on and the load is connected. The red LED indicates that the mains is outside the window, and the load is disconnected.
5. Frequency and Phase Error indications, where fitted, are by separate red LEDs.

SPECIFICATIONS

Model AVS303	
Current (Amps)	23 to 1250
Nominal voltage(V)	230/400
Wait time (mins)	10 secs to 10 minutes
Under-voltage disconnect(V)	190V (150 - 230V)
Over-voltage disconnect(V)	260V (150 - 230V, also off)
Hysteresis(V)	4
Socket type	direct via brass screw terminal
Fused plug	N/A
RFI protection	No
Transient suppression	Yes >6.5kA
Spike protection(J)	160

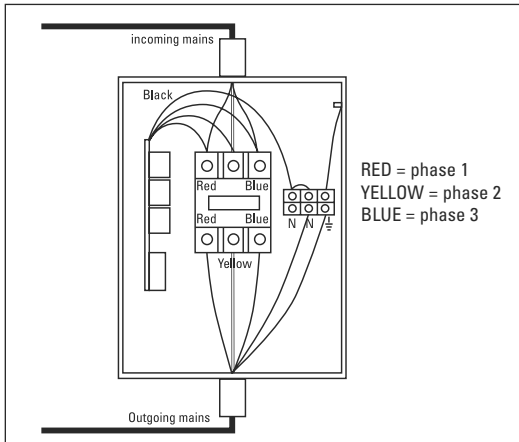

WIRING

From the incoming mains:



















1. Connect Neutral to the Neutral on the terminal block
2. Connect Phase 1 to where the RED WIRE is connected on the contactor
3. Connect Phase 2 to where the YELLOW WIRE is connected on the contactor
4. Connect Phase 3 to where the BLUE WIRE is connected on the contactor

For the outgoing mains: mirror the above connections.















SOLLATEK PRODUCT RANGE COMPARISON CHART The following chart



Prevents damage to equipment from over or under voltage levels of long duration. Works by disconnecting power when voltage level exceeds set parameters. Reconnects again when power returns inside parameters for a pre-set period. Fully automatic operation. All switchers include other protection features.

	 HiVoltGuard	 TVGuard	 FridgeGuard	 VoltGuard	 LightingGuard	 Automatic Voltage Switcher AVS13/15	 A/C Guard	 Automatic Voltage Switcher AVS30	 Automatic Voltage Switcher AVS100	 Automatic Voltage Switcher AVS303
 Low Voltage			✓	✓		✓	✓	✓	✓	✓
 High Voltage	✓	✓		✓	✓	✓	✓	✓	✓	✓
 RFI / Noise						✓ (AVS13RL only)				
 Spikes/Surges	✓	✓	✓	✓	✓	✓	✓	✓	✓	✓
 Bolt Lightning	✓	✓	✓	✓	✓	✓	✓	✓	✓	✓
 Power Cuts										
 Power-Back Surge	✓	✓	✓	✓	✓	✓	✓	✓	✓	✓
 Telecom Surges					✓					
Amps	5	5	5	7	5	13/15	up to 25	30	100	23 to 1250
Single phase	✓	✓	✓	✓	✓	✓	✓	✓	✓	
Three phase										✓
Connect by	Plug/socket	Plug/socket	Plug/socket	Plug/socket	Plug/socket + data	Plug/socket	Direct wiring	Direct wiring	Direct wiring	Direct wiring
Suitable for	TV VCR HiFi radio etc	TV LCD/Plasma screens VCR HiFi Fax machines etc	Fridge Freezer Cooler etc	TV VCR HiFi Radio Fridge Freezer etc	Telecoms equipment internet Broadband PC modem data etc	Any electrical or electronic equipment (incl.air con)	Air conditioning equipment	Any electrical or electronic equipment (incl.air con)		Air con ma industri

gives an overview of most of the Sollatek range of products and the protection they offer.

	 Voltsafe™ The Sollatek Suppressor Range <i>Stops short-term disturbances, created by lightning strikes, power stations or nearby equipment switching on & off, from causing damage.</i>						 Voltright™ The Sollatek Regulator Range <i>Ensures equipment can still operate although the voltage level is outside its 'normal' range, by automatic correction within set levels.</i>			 Voltsure™ The Sollatek UPS Range <i>Keeps equipment operating temporarily in a blackout by using stand-by battery power</i>	
											
	✓						✓	✓	✓	✓	✓
	✓						✓	✓	✓	✓	✓
				✓ (MG4, MG5)	✓		(optional)	(optional)	(optional)	✓	✓
	✓	✓	✓	✓	✓	✓	✓	✓	✓	✓	✓
	✓	✓	✓	✓	✓	✓	✓	✓	✓	✓	✓
								✓			✓
	✓						✓	(optional)		✓	✓
			✓	✓ (MG3, MG5)						✓	✓
	unlimited	13	13	13	3 to 13	unlimited	1 to 75	1 to 400	20 to 3000	1.5 to 8	1.5 to 8
		✓	✓	✓	✓	✓	✓	✓		✓	✓
	✓				✓	✓	✓	✓	✓		
	Direct wiring	Plug/socket	Plug/socket + data	Plug/socket	Plug/socket	Direct wiring	Plug/socket + direct wiring	Plug/socket + direct wiring	Plug/socket	Plug/socket	Plug/socket
chinery for al plants	Any electrical or electronic equipment	CPU Fax Modem Phone equipment	Any electrical or electronic equipment on multi way strip	Any electrical or electronic equipment	Any electrical or electronic equipment	Whole building electrical or electronic equipment 1 or 3 phase	Any electrical or electronic equipment	Sensitive electrical or electronic equipment		Computers, Servers, Telecom and any vital equipment.	

POWER PROBLEMS AND THEIR ASSOCIATED CAUSES

All electrical and electronic equipment, connected to the mains supply is at risk of being damaged from spikes, surges, lightning, brown-outs, power-cuts (blackouts), power back surges, and over-voltage. The following is a summary of the main types of power problems, causes and how these affect electrical and electronic equipment.



Spikes/Surges

Spikes/Surge: Very short, (one millisecond) event of very high surge in voltage to thousands of volts and amps. Spikes are common in all parts of the world and repeated exposure to spikes will damage electronic equipment and corrupt data.

What causes it? Switching on/off of nearby equipment, lightning, motors starting etc.



RFI / Noise

RFI (Radio Frequency Interference)/Noise: High frequency disturbances that occur within a short period of time (milliseconds). RFI & noise are very common in all parts of the world and are the main cause of data corruption.

What causes it? Generated by high frequency noise from nearby equipment like TV, radio equipment, transmitters, mobile phones, switching on/off of certain loads, fluorescent lights, motor speed controls, light dimmers.



High Voltage

Over-Voltage: Long duration (milliseconds, seconds, minutes, hours or days) rise in the voltage above acceptable limits. Depending on the level of the over-voltage, the damage can be instantaneous, severe and irreparable.

What causes it? On return of mains supply after power cuts, under-sized utility oscillating between periods of brown-outs and over-voltage or accidental (e.g. accidental connection between two phases).



Low Voltage

Brown-Out: Long duration of low voltage (milliseconds to seconds, minutes, hours or days). Very common in parts of the world especially where the power utilities are over-stretched. Prolonged and frequent brownouts cause the equipment to malfunction or not work at all. Repeated episodes are certain to cause damage. Motors and compressors (and therefore fridges, freezers, coolers, air-conditioners and pumps) are especially at risk. In time, damage is certain.

What causes it? Most commonly an over-stretched utility, especially in areas of poor power distribution infra-structure and remote areas. Common in dry seasons where water is used for electricity generation.



Basic
Lightning

Basic Lightning: Direct or nearby strikes can cause minor problems or severe disturbances and damage. Lightning produces spikes/surges, over-voltage or power cuts.

What causes it? The surge is generated by either a direct hit, or indirectly striking underground or overhead lines and transmitting high surges to connected equipment in nearby buildings.



Power Cuts

Power-cuts: Common in many countries in the world, especially in areas of frequent voltage problems. Sudden loss of power can cause damage ranging from corruption of data to mechanical faults as equipment is stopped while in operation.

What causes it? Power or sub station failure, breakdown in the distribution network, or simply a plug being pulled out accidentally.



Power-Back
Surges

Power-Back Surges: These typically occur when power returns after a power-cut and connected equipment receives a surge of electricity at an over-voltage level, which can be very damaging (see above).

What causes it? Power back surges are created by the utility, when it restores supply at an above normal voltage in order to compensate for the demand as connected equipment re-starts simultaneously.



Telecom Surges

Telecom surges, spikes and lightning: Short term, high voltage and current phenomena occurring on the telephone lines. Can cause irreparable damage to any piece of equipment connected to the incoming line. The telephone line itself may even be damaged or destroyed in severe cases.

What causes it? Telecom spikes are caused by lightning striking either the telephone line directly or an object near it.



Sollatek (UK) Ltd. Sollatek House. Waterside Drive. Langley. Slough. SL3 6EZ United Kingdom
Tel: +44 (1753) 214 500 Technical support: support@sollatek.com
Sales: sales@sollatek.com www.sollatek.com