



Voltshield™

AUTOMATIC VOLTAGE SWITCHER (AVS15 MICRO)

OVER AND UNDER VOLTAGE PROTECTION

Description

The AVS is an Automatic Voltage Switcher rated at 15 Amps (AVS15). The AVS will switch off the equipment connected to it if the mains power goes outside preset acceptable limits and will re-connect automatically* - when the mains power returns to normal. Re-connection takes place after a delay ('the start-up delay') to ensure stability of the mains.

In addition, the start-up delay provides protection against power-back surges commonly experienced after resumption of power in a power cut situation.



Surge and spike protection is also incorporated to ensure protection against these commonly occurring events.

* unless set to MANUAL on the Time Delay dial.

Function

This new version of the AVS has a built-in microprocessor that has added advanced features to the product. These include:

Five voltage indicators

- ✓ The power supply is good and the load is connected.
- Hi** The AVS has detected that the mains voltage is too high and therefore dangerous to your equipment. The AVS has disconnected the power supply.
-  Power supply has returned to normal (after an over-voltage condition - see above). The AVS is waiting before the power supply is restored to your equipment.
-  Power supply has returned to normal (after an under-voltage condition - see below). The AVS is waiting before the power supply is restored to your equipment.
- Lo** The AVS has detected low voltage condition and has disconnected the power to your equipment to protect against it.



LOAD ON/OFF Switch

Using this button,  you can switch your equipment on or off. If the switch is in the off position (Light bulb off), press the switch to turn the equipment on. PLEASE NOTE THAT THE EQUIPMENT WILL BE CONNECTED AFTER THE DELAY HAS PASSED AS SET BY THE TIME DELAY DIAL.

Time Delay dial

By adjusting the dial, you can set the start-up delay (after first connecting and after re-connection in case of over or under-voltage) from 15 seconds to 3 minutes (AVS13) or 1.5 minutes to 5 minutes (AVS15). Alternatively you can pre-set to MANUAL. MANUAL indicates that the AVS will not connect your load until you press the LOAD ON/OFF switch.

Use MANUAL setting if you do not want equipment to automatically re-start for example if you do not wish the air-conditioner to re-connect automatically after a power cut.

Applications

All electrical and electronic equipment including air conditioners, large fridges/freezers etc.

Protection against:

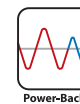
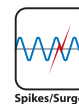
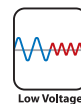
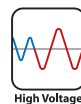

Features:

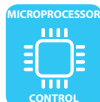

Protection for:



Specifications

| Model | AVS15 |
|---|---|
| Nominal voltage | 230V |
| Watts | 3600 |
| Frequency | 50/60 Hz |
| Load current (Amps) | 15 |
| Inrush current (20ms) | 110 Amps |
| Max consumption (milli Amps) | <100mA |
| Wait time | 15secs-3mins |
| Over-voltage disconnect | 265V |
| Over-voltage reconnect | 263V |
| Under-voltage disconnect | 185V |
| Under-voltage reconnect | 190V |
| Max operating voltage (U _c) | 320V |
| Spike / surge protection (Class II) | Joules 160 Amps 6500A (8/20us) Response 10 nanosecs |
| Protection mode: | L-N |
| Response time (over voltage) | <20 millisec |
| Response time (under voltage) | 1 second |
| Brown-out response time | 20 millisec |
| Approx packed weight | 500 g |
| Dimensions packed (mm) | H 230 x W 134 x D 54 |
| Shipping quantity per carton | 40 |
| Shipping carton dimensions (mm) | H 590 x W 540 x D 250 |
| Socket type | UK 15Amp |
| (other sockets available upon request) | |

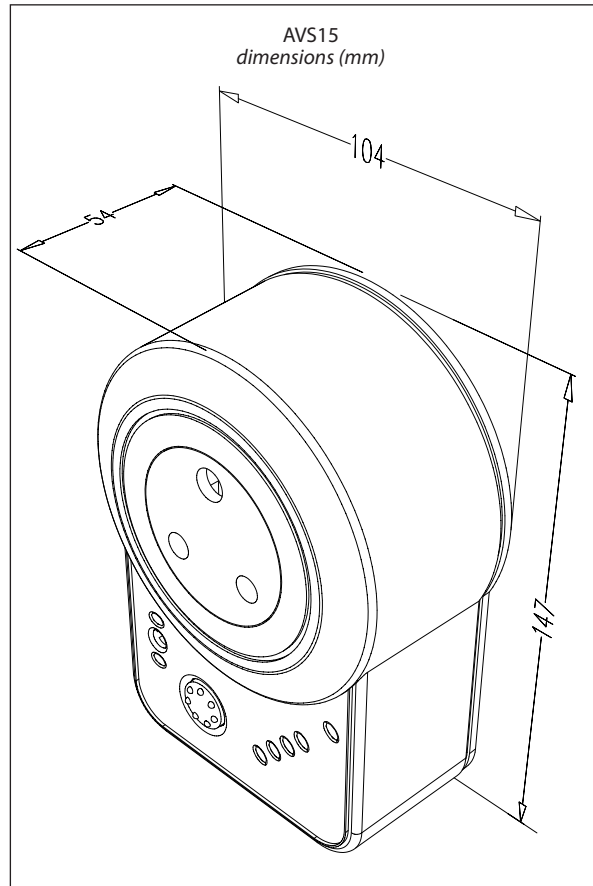

TIMESAVE™ description

The Voltshield has a built-in microprocessor which adds the advanced feature TimeSave™. TimeSave™ means that when the mains returns to normal, the Voltshield checks the duration of the OFF time. If the unit has been off for more than 3 minutes then it will reconnect the mains within 30 seconds rather than the standard 3 minutes. This means the Sollatek Voltshield will give you more vital working time than any other switcher.

The VOLTSHIELD features

- Protects and prolongs the useful life of electrical appliances
- Eliminates the need to switch off appliances every time the electricity fails
- Safeguards valuable electrical appliances at all times
- Very low cost protection in relation to the value of appliances
- Different models available

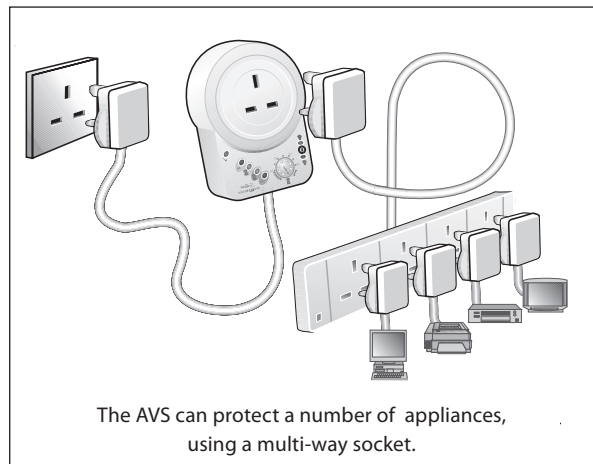

The AVS can protect a number of appliances, using a multi-way socket.

ITEM
AVS15 – 3 ROUND PIN 230V

PRODUCT CODE
91155000

For more information on the Sollatek's Voltage Switcher Range refer to the **Voltshield** brochure or visit www.sollatek.com

Sollatek™

Sollatek (UK) Ltd.

Unit 10, Poyle 14, Newlands Drive, Poyle, Slough, SL3 0DX, UK

Tel: +44 (0)1753 688300 Fax: +44 (0)1753 685306

Technical support: support@sollatek.com

Sales: sales@sollatek.com www.sollatek.com