

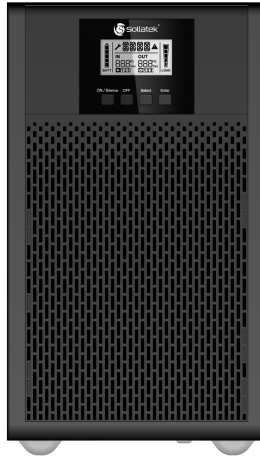

# User Manual



## Maxima Online 3kVA

Uninterruptible Power Supply (UPS)



# CONTENT

<b>1. SAFETY AND EMC INSTRUCTIONS .....</b>	<b>1</b>
1.1 INSTALLATION .....	1
1.2 OPERATION .....	3
1.3 MAINTENANCE, SERVICING AND FAULTS .....	3
1.4 TRANSPORT .....	4
1.5 STORAGE .....	5
1.6 STANDARDS.....	5
<b>2. DESCRIPTION OF COMMONLY USED SYMBOLS.....</b>	<b>6</b>
<b>3. INTRODUCTION.....</b>	<b>6</b>
<b>4. PANEL DESCRIPTION.....</b>	<b>8</b>
4.1 BUTTON .....	8
4.2 LCD DESCRIPTION .....	10
<b>5. CONNECTION AND OPERATION .....</b>	<b>12</b>
5.1 INSPECTION:.....	12
5.2 CONNECTION:.....	12
5.3 BATTERY RECHARGE:.....	15
5.4 TURN ON THE UPS: .....	15
5.5 TEST FUNCTION:.....	16
5.6 TURN OFF THE UPS:.....	16
5.7 AUDIBLE ALARM MUTE FUNCTION: .....	16
<b>6. OPERATING MODE FOR ALL MODELS .....</b>	<b>18</b>
6.1 LINE MODE .....	19
6.2 BATTERY MODE .....	20
6.3 BYPASS MODE .....	20
6.4 NO OUTPUT MODE.....	21
6.5 EPO (EMERGENCY POWER OFF).....	21
6.6 ECO MODE (ECONOMY MODE) .....	21
6.7 CVCF MODE .....	22
6.8 ABNORMAL MODE .....	22
<b>7. SETTING BY LCD MODULE.....</b>	<b>23</b>
<b>8. TROUBLESHOOTING.....</b>	<b>27</b>
<b>9. MAINTENANCE.....</b>	<b>31</b>
9.1 OPERATION .....	31
9.2 STORAGE .....	31

<b>10. TECHNICAL DATA .....</b>	<b>32</b>
10.1 ELECTRICAL SPECIFICATIONS .....	33
10.2 OPERATING ENVIRONMENT .....	34
10.3 DIMENSIONS AND WEIGHTS .....	34
<b>11. COMMUNICATION PORT .....</b>	<b>35</b>
11.1 USB AND RS-232 (OPTIONAL) COMMUNICATION PORTS .....	35
11.2 USB FOR HID POWER DEVICE .....	35
11.3 AS400 INTERFACE (OPTIONAL).....	35
11.4 CMC INTERFACE (OPTIONAL) .....	35
11.5 NMC INTERFACE (OPTIONAL) .....	36
<b>12. SOFTWARE .....</b>	<b>36</b>
<b>APPENDIX: REAR PANEL .....</b>	<b>37</b>

# 1. Safety and EMC Instructions



Please carefully read the following user manual and safety instructions before installing or operating the unit.

## 1.1 Installation

- Refer to the installation instructions before connecting to the mains power.
- Condensation may occur if the UPS is moved directly from a cold to a warm environment. Ensure the UPS is completely dry before installation. It is recommended to allow at least two hours for acclimatisation.
- Do not install the UPS near water or in a damp environment.
- Avoid installing the UPS in areas exposed to direct sunlight or near sources of heat.
- Do not connect appliances or equipment that could overload the UPS (e.g., laser printers) to the UPS output.
- Arrange cables properly to prevent tripping or stepping on them.
- Ensure a reliable earth connection is established.
- Connect the UPS only to a properly earthed shockproof socket outlet.
- The building wiring socket outlet (shockproof socket outlet) must be easily accessible and close to the UPS.
- Ensure the total leakage current of the UPS and connected load does not exceed 3.5mA.
- Do not block the ventilation openings on the UPS housing. Make sure the air vents on the front, sides, and rear of the UPS remain unobstructed.

- It is recommended to leave at least 25 cm of space on each side. The airflow diagram is shown below:

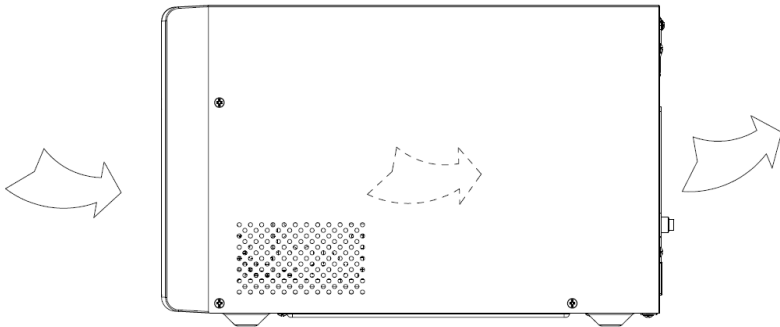

■ **Figure 1.1 The Air Flow Diagram**

- This UPS receives power from multiple sources. Disconnection of both the AC source and the DC source is required to fully de-energise the unit before servicing.
- An additional circuit breaker or fuse with rating of 16A and breaking capacity of 3kA shall be used between power source and input when installing this unit.

## 1.2 Operation

- For safety, do not disconnect the mains cable from the UPS or the building wiring socket (grounded shockproof socket) during operation, as this will disconnect the grounding for the UPS and all connected loads.
- The UPS has its own internal current source (batteries). You may experience an electric shock if you touch the UPS output sockets or output terminal block, even if the UPS is not connected to the building wiring socket.
- To fully disconnect the UPS, first press the OFF button to turn off the UPS, and then disconnect the mains lead.
- Ensure that no liquid or external objects can enter the UPS.
- Do not remove the enclosure. This system must only be serviced by qualified service personnel. There are NO USER-SERVICEABLE PARTS inside the UPS.
- Remove the protective panel only after disconnecting the terminal connections.

## 1.3 Maintenance, Servicing and Faults

- The UPS operates with hazardous voltages. Repairs must only be carried out by qualified maintenance or service personnel.
- Caution – risk of electric shock. Even after the unit is disconnected from the mains power supply (building wiring socket), components inside the UPS remain connected to the battery and may still be potentially dangerous.
- Before performing any service or maintenance, disconnect the batteries. Verify that no current is present and that no hazardous voltage exists in the capacitors or BUS capacitor terminals.
- Batteries must only be replaced by qualified personnel.

- Caution – risk of electric shock. The battery circuit is not isolated from the input voltage. Hazardous voltages may occur between the battery terminals and the ground. Verify that no voltage is present before servicing!
- Batteries have a high short-circuit current and pose a risk of shock. Take all the precautionary measures specified below, as well as any other necessary safety measures when working with batteries:
  - Remove all jewellery, wristwatches, rings, and other metal objects.
  - Use only tools with insulated grips and handles.
  - Wear rubber gloves and boots.
  - Do not place tools or metal parts on top of batteries.
- Disconnect the charging source before connecting or disconnecting battery terminals.
- When replacing batteries, ensure you use the same quantity and type of batteries.
- Do not attempt to dispose of batteries by burning them, as this could cause an explosion.
- Do not open or destroy batteries. Leaking electrolyte can cause injury to the skin and eyes and may be toxic.
- Replace fuses only with fuses of the same type and amperage to avoid fire hazards.
- Do not dismantle the UPS unless performed by qualified maintenance personnel.

## 1.4 Transport

- Transport the UPS only in the original packaging (to protect against shock and impact).

## 1.5 Storage

- The UPS must be stockpiled in a room that is ventilated and dry.











## 1.6 Standards

SAFETY	
IEC/EN 62040-1	
EMI	
Conducted Emission	IEC/EN 62040-2
Radiated Emission	IEC/EN 62040-2
Harmonic Current	IEC/EN 61000-3-2
Voltage Fluctuation and Flicker	IEC/EN 61000-3-3
EMS	
ESD	IEC/EN 61000-4-2
RS	IEC/EN 61000-4-3
EFT	IEC/EN 61000-4-4
SURGE	IEC/EN 61000-4-5
CS	IEC/EN 61000-4-6
MS	IEC/EN 61000-4-8
Voltage Dips	IEC/EN 61000-4-11
Low Frequency Signals	IEC/EN 61000-2-2



## 2. Description of Commonly Used Symbols

Some or all of the following symbols may appear in this manual. It is advisable to familiarise yourself with them and understand their meanings:

Symbol and Explanation			
Symbol	Explanation	Symbol	Explanation
	Alert you to pay special attention		Alternating current source (AC)
	Caution of high voltage		Direct current source (DC)
	Turn on the UPS		Protective ground
	Turn off the UPS		Recycle
	Idle or shut down the UPS		Do not dispose with ordinary trash

## 3. Introduction

The Maxima Online 3kVA is an uninterruptible power supply (UPS) incorporating double-conversion technology. It provides optimal protection specifically for Linux, UNIX, and Windows servers. The double-conversion principle eliminates all mains power disturbances. A rectifier converts the alternating current (AC) from the socket outlet into direct current (DC).

This DC charges the batteries and powers the inverter. Based on this DC voltage, the inverter generates a sinusoidal AC voltage, which continuously supplies the connected loads.

Computers and peripherals are thus powered entirely by the UPS. In the event of a power failure, the maintenance-free batteries continue to power the inverter.

This manual covers the UPS models listed below. Please confirm that it is the model you intend to purchase by visually inspecting the Model No. on the rear panel of the UPS.

## The Model List

Item	Model name	Power Rating	Model type	Model description	Other
3K	Maxima Online 3kVA	3000VA/ 2700W	Tower	Standard model	Single Phase input Single Phase Output

## UPS Block Diagram

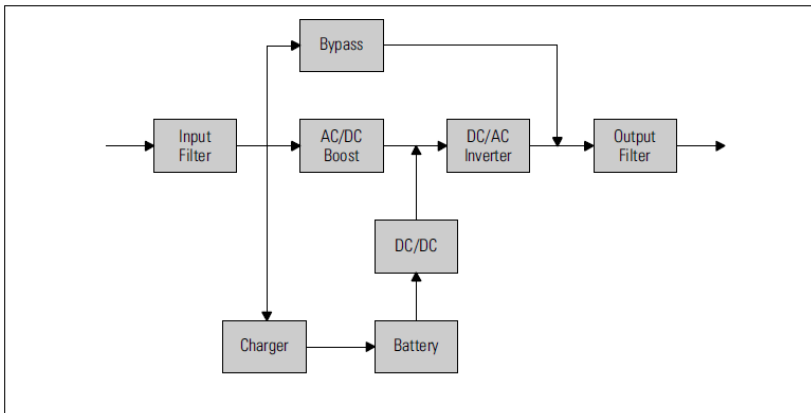

# 4. Panel Description

The display panel of Maxima Online 3kVA is shown below:

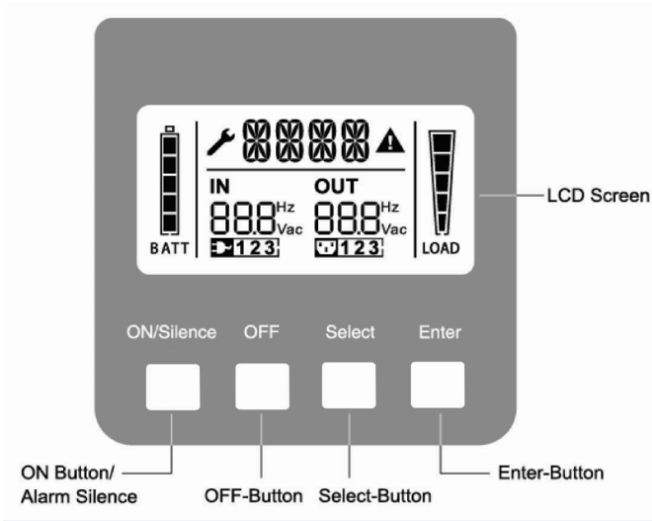

■ Figure 4.1 The Display Panel

## 4.1 Button

Switch	Function
<b>ON/Silence Button</b>	<p><b>Turn on the UPS system:</b> Press and hold the ON button for more than 1 second to turn on the UPS system.</p> <p><b>Deactivate the acoustic alarm:</b></p> <ul style="list-style-type: none"> <li>• Press this button to deactivate the acoustic alarm in battery mode.</li> <li>• With a short press, this button deactivates all acoustic alarms in all modes.</li> </ul> <p><b>Perform the battery test:</b> Press this button to perform the battery test while the UPS is in Line mode, ECO mode, or CVCF mode.</p>
<b>OFF Button</b>	<p><b>When mains power is normal:</b> The UPS system switches to No Output or Bypass mode when</p>

	<p>the OFF button " " is pressed, and the inverter is turned off. At this time, if Bypass mode is enabled, the output sockets are supplied with voltage via the bypass, if mains power is available.</p> <p><b>Deactivate the acoustic alarm:</b> Press this button to deactivate the acoustic alarm in Bypass mode.</p> <p><b>Release the UPS from fault mode and EPO status:</b> Follow the necessary procedures to release the UPS from fault mode and Emergency Power Off (EPO) status.</p>
<b>Select Button</b>	<p>The output voltage, frequency, Bypass enable/disable setting, operating mode in No Output or Bypass mode, external battery pack count, battery remaining time display enable/disable setting, and charger current in all modes can be selected by pressing the <b>Select</b> button and confirmed by pressing the <b>Enter</b> button.</p>
<b>Enter Button</b>	



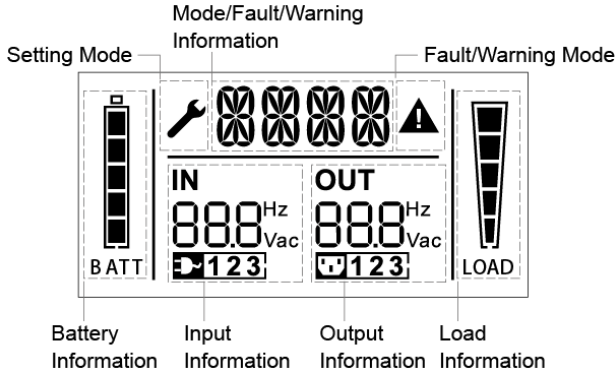

Note: External Battery pack number cannot be selected for standard model Maxima 3 kVA

## 4.2 LCD Description



■ Figure 4.2 The LCD Display

Display	Function
<b>Input Information</b>	
	Input voltage/frequency value, which are displayed alternately.
	Indicates that the input is connected with mains, and the input power is single phase input.
<b>Output Information</b>	
	Output voltage/frequency value, which are displayed alternately.
<b>Load Information</b>	
	Shows the load level, every grid represents the level of 20%. One grid would be displayed if the level is 0~20%

Battery Information	
 BATT	<p>Battery capacity, every grid represents the capacity of 20%. If the battery low alarm occurs, the lowest grid will flash to remind you.</p>
Mode/Fault/Warning Information	
	<p>Operating mode or Fault Type or Warning Type or Battery Remain Time, several warning kinds at the same time could be displayed alternately.</p>
Other Icons	
	<p>Shows the UPS is in the settings mode.</p>
	<p>UPS is in Fault Mode or has some warnings.</p>
<p>LCD IDLE FUNCTION</p>	<p>If you enable the LCD idle function, when the UPS switches to standby mode, the LCD background will turn off within 5 seconds. After any key is pressed, the LCD background will light up.</p>

## 5. Connection and Operation



The system may only be installed and wired by qualified electricians in compliance with applicable safety regulations.

When installing the electrical wiring, ensure you consider the nominal amperage of your incoming feeder.

### 5.1 Inspection:

Inspect the packaging carton and its contents for any damage. If you notice signs of damage, inform the transport agency immediately.

Retain the packaging in a safe place for future use.

**Note:** *To avoid any safety issues, ensure that the incoming feeder (mains) is completely isolated throughout the entire installation process.*

### 5.2 Connection:

#### (1) UPS Input Connection

If the UPS is connected via a power cord, please ensure the use of a suitable socket with adequate protection against electric current and verify that the socket's capacity is sufficient. The UPS system is equipped with an input breaker located on the standard cabinet.

#### (2) UPS Output Connection

The output sockets and their types for the UPS are shown below:

Model No.	Output Socket IEC (pcs)
Maxima Online 3kVA	4*C13+1*C19

Connect the output and ground wires to the terminal block.

Terminal Position	Wire Function	Terminal Wire Size Rating	Tightening Torque
L	Line Out	1.5mm <sup>2</sup> -2.5mm <sup>2</sup> (14AWG-12AWG )	0.5Nm(4.4 Lb In)
N	Neutral Out		
	Output Ground		

### (3) Battery Input Connection for Long Backup Time Model

When connecting the external batteries it is recommended to pay attention to the following items:

- Use the battery pack with the following voltage specifications:
  - **72VDC** for Maxima 3 kVA (with EBM connector), using 6 pieces of 12V batteries.

**Note: Connecting batteries in quantities greater or fewer than required may cause abnormalities or permanent damage.**

- A standard battery connector on the rear panel is used for connecting the battery pack.
- The battery connection procedure is critical. Non-compliance may result in the risk of electric shock. Therefore, the following steps must be strictly followed:
  - Prepare a battery cable with a standard connector capable of carrying the required current.
  - If a battery breaker is present, turn it off first. Then, connect the battery cable to the standard battery connector on the rear panel.
  - Connect the UPS input power cord to the mains power supply. The battery will then begin to charge.





A DC breaker must be connected between the UPS and the external battery if a standard battery pack is not used.

The output sockets of the UPS system may remain electrically live even if the power supply system has been disconnected.

#### (4) EPO Connection:

The Emergency Power Off (EPO) function is a standard feature of the UPS. The polarity of the EPO is configurable, with the default setting being normally closed. If the connection between the two ports of the EPO connector is interrupted, the EPO function will activate, causing the UPS to immediately stop outputting power.

- **NORMALLY OPEN**

The EPO connector is normally open on the rear panel. Once the connector is closed with a wire, the UPS will stop outputting power until the EPO status is reset.

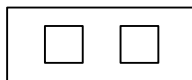

Disable EPO status

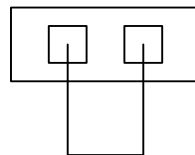

Enable EPO status

- **NORMALLY CLOSE**

The EPO connector is normally closed with a wire on the rear panel. If the connector is opened, the UPS will stop outputting power until the EPO status is disabled.

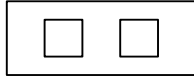

Enable EPO status

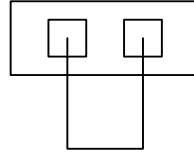

Disable EPO status

### 5.3 Battery Recharge:

Fully charge the external batteries of the UPS system by keeping the UPS system connected to the mains power for approximately 1–2 hours. While the UPS system can operate directly without this charging process, the backup time may be shorter than the specified nominal value.

### 5.4 Turn on the UPS:

#### (1) With mains power connecting:

Press and hold the On button for more than 1 second to turn on the UPS. The UPS will enter Line mode, and the LCD screen will display the current state of the UPS.

#### (2) Without mains power connecting:

Even if mains power is not connected to the UPS, the UPS can still be turned on by simply pressing and holding the On button for more than 1 second, provided that external batteries are connected. The UPS will enter Battery mode, and the LCD screen will display the current state of the UPS.

**Note:** *The default setting for bypass mode is set to no output after the UPS is connected to mains power and the breaker is turned on. This setting is configurable.*

## 5.5 Test Function:

The Test Function checks the battery performance of the UPS system. By pressing and holding the On button for more than 1 second while the UPS is operating in Line mode, the UPS will detect whether the battery is properly connected or if it is weak. The UPS can also perform this test automatically and periodically, with the testing interval being configurable.

## 5.6 Turn off the UPS:

### (1) In Line Mode:

Press and hold the Off button for more than 1 second to turn off the UPS. The UPS will enter no output or bypass mode. In some cases, the UPS may still provide output power if bypass mode is enabled. To completely turn off the output, disconnect the mains power.

### (2) In Battery Mode:

Press and hold the Off button for more than 1 second to turn off the UPS. The UPS will enter no output or standby mode. After 10 seconds, the UPS will shut down completely.

## 5.7 Audible Alarm Mute Function:

If the audio alarm is too disruptive, it can be muted in different modes as follows:

### • **Battery Mode:**

To mute the audio alarm, press and hold the On button for more than 1 second. The alarm will be reactivated automatically when the battery reaches a low level to remind you that the UPS output power will shut down soon.

### • **Bypass Mode:**

To mute the audio alarm, press and hold the Off button for more than 1 second. This action does not affect warning or fault alarms.

- **Warning or Fault Alarms** (in any mode):

If the warning or fault alarm is too annoying, you can mute it by pressing the On button for less than 0.5 seconds. To re-enable the alarm, press the On button again for less than 0.5 seconds. If a new warning or fault condition arises, the buzzer will sound again.

- **CVCF Mode (Constant Voltage and Constant Frequency):**

When using CVCF mode without batteries, if the open battery alarm is too disruptive, it can be muted via the software configuration.

**Alarm Table List**

NO.	Status	Alarm
1	Battery mode	Beep once every 4 sec
2	Battery mode with battery low	Beep once every sec
3	Bypass mode	Beep once every 2 min
4	Overload	Beep twice every sec
5	Warning active (see Warning& Fault Code Table )	Beep once every sec
6	Fault active	Beep continuously
7	Button function active	Beep once

## 6. Operating Mode for All Models

Different messages/strings will be displayed on the LCD screen corresponding to different UPS operating modes, as shown in Table 6.1. Different warning/fault codes are detailed in Table 6.2. Only one normal operating string or fault string is presented at a time. However, if several warnings occur simultaneously, they will be displayed alternately on the LCD. In such cases, the normal operating mode string and the warning strings will be shown in rotation. Once a fault occurs, all previous warnings will no longer be displayed; only the fault string will be presented.

Table 6.1: Operating Mode

Operating Mode	Code
No output mode	STbY
Bypass mode	bYPA
Line mode	LINE
Battery mode	bATT
Battery test mode	TEST
ECO mode	ECO
Converter mode	CVCF

Table 6.2 : Warning & Fault Code

Warning	String
Site fail	SITE
Fan fail	FANF
Battery over voltage (over charged)	HIGH
Battery low	bLOW
Charge fail	CHGF
Inverter temperature high	TEPH
Battery open	bOPN

Overload	OVLD
Digital bigger charger fail	dCHF
Inner temperature high	ITPH
<b>Fault</b>	<b>String</b>
Inverter short	SHOR
Overload fault	OVLD
Inverter soft start fail	ISFT
Bus soft start fail	bSFT
Over temperature fault	OVTP
Inverter Volt Low	INVL
Inverter Volt High	INVH
Bus volt over	bUSH
Bus volt Low	bUSL
Bus short	bUSS
Inverter NTC open	NTCO
Emergency Power Off	EPO

## 6.1 Line Mode

The LCD display in Line mode is shown in Figure 6.1. Information about the mains power, battery level, UPS output, and load level will be displayed. The "LINE" string indicates that the UPS is operating in Line mode.

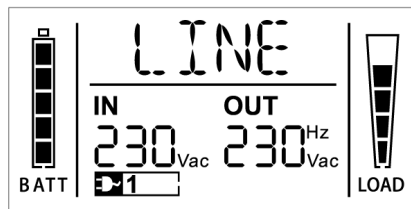

■ Figure 6.1 The Line mode

## 6.2 Battery Mode

The LCD display in Battery mode is shown in Figure 6.2. Information about the battery voltage, battery level, UPS output, and load level will be displayed. The “bATT” string indicates that the UPS is operating in Battery mode. If the function for displaying the battery remaining time is enabled, the “bATT” string and the remaining battery time (in minutes or seconds) will alternate every 2 seconds.

When the UPS is running in Battery mode, the buzzer beeps once every 4 seconds. If the “ON” button on the front panel is pressed and held for more than 1 second, the buzzer will stop beeping (entering silence mode). Pressing the “ON” button again for more than 1 second will resume the alarm function.

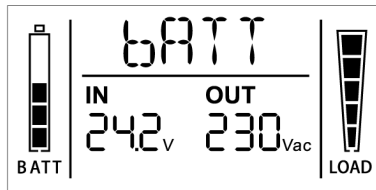

■ Figure 6.2 The Battery mode

## 6.3 Bypass Mode

The LCD display in Bypass mode is shown in Figure 6.3. Information about the mains power, battery level, UPS output, and load level will be displayed. In Bypass mode, the UPS will beep once every 2 minutes. The “bYPA” string indicates that the UPS is operating in Bypass mode.

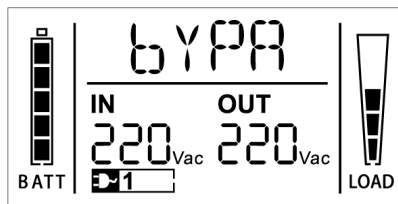

■ Figure 6.3 The Bypass mode

## 6.4 No Output Mode

The LCD display in No Output mode is shown in Figure 6.4. Information about the mains power, battery level, UPS output, and load level may be displayed. The “STbY” string indicates that the UPS is operating in No Output mode.

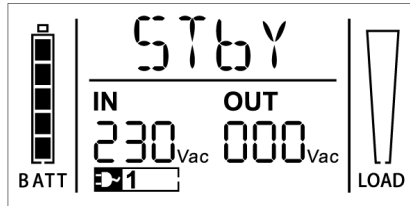

■ Figure 6.4 The No output mode

## 6.5 EPO (Emergency Power Off)

This mode is also referred to as RPO (Remote Power Off). On the LCD display, the word “EPO” will appear in the position of the output voltage. This is a special status in which the UPS shuts off its output and triggers an alarm. The UPS cannot be turned off by pressing the “OFF” button on the panel; it can only be restored to normal operation after the EPO status has been reset.

## 6.6 ECO Mode (Economy Mode)

This mode is also referred to as High Efficiency Mode. When the UPS is turned on in ECO mode, the output power is supplied directly from the mains power through an internal filter, provided the mains power is within a specified range. This allows the UPS to achieve high efficiency in ECO mode. If the mains power is lost or goes out of range, the UPS will switch to Battery mode, ensuring uninterrupted power supply to the load from the battery.

1. ECO mode can be enabled through the LCD settings or software such as Winpower.



- The transfer time from ECO mode to Battery mode is less than 10ms. It is recommended to consider this transfer time when using ECO mode for applications with sensitive loads.

## 6.7 CVCF Mode

CVCF (Constant Voltage Constant Frequency) mode, also known as Converter Mode, allows the UPS to operate in frequency free-run with a fixed output frequency (either 50Hz or 60Hz). If the mains power is lost or becomes abnormal, the UPS will switch to Battery mode, ensuring continuous power supply to the load via the battery.

CVCF mode can be enabled through the LCD settings or software such as Winpower. In Converter Mode, the normal power rating is derated to 60%.

## 6.8 Abnormal Mode

In abnormal modes, such as a bus fault, the corresponding fault string will be displayed on the LCD to indicate the UPS status, and the background light will turn red. For example, "SHOR" will be displayed if the connected load or the UPS output is short-circuited. The LCD display for this scenario is illustrated in Figure 6.5.

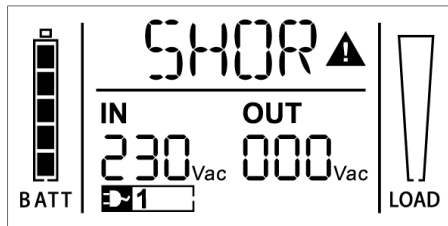

■ Figure 6.5 The Fault mode

## 7. Setting by LCD Module

The output voltage/frequency, auto bypass status, operating mode (in No Output mode or Bypass mode), charger current, external battery pack number, and battery remaining time function in all modes can be set directly through the LCD module.

In Bypass or No Output mode, pressing the “Enter” button on the LCD panel for more than 1 second enters the setting mode. The LCD display is shown in Figure 7.1. The string “OPV” represents output voltage, and “230Vac” indicates that the current output voltage is set to 230Vac.

To adjust the output voltage:

- Press the “Enter” button for more than 1 second, and a flickering string, such as “220,” will appear.
- If the “Enter” button is pressed again, the string “220” will stop flickering, and the output voltage will change to 220V.
- To select a different voltage, press the “Select” button for more than 1 second. The next flickering string, such as “230,” will appear.
- The order of flickering strings cycles through 220 – 230 – 240 – 220 – 230.
- Press the “Enter” button to confirm the desired output voltage.

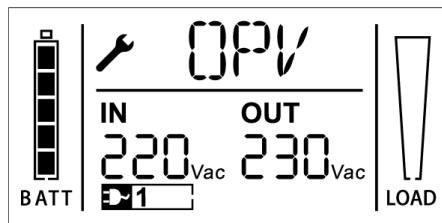

■ Figure 7.1 Setting by LCD

To exit the settings mode, press the “Enter” button once. To continue adjusting settings, press the “Select” button. If neither the “Select” nor

"Enter" button is pressed for more than 10 seconds, the settings mode will exit automatically.

The following strings will be displayed in a circular sequence: output frequency ("OPF"), bypass status ("bYPA"), operating mode ("MOdE"), external battery pack number ("EbPN"), battery remaining time ("bATT"), and charger current ("CHG").

You can select only one voltage value at a time from "220V", "230V", or "240V". Similarly, only one frequency value can be selected at a time, either "50Hz" or "60Hz". The bypass status can be set to "000" or "001" (where "000" means Bypass Disabled and "001" means Bypass Enabled). If "Bypass Enabled" is selected, the UPS will switch to bypass mode after a few seconds; if "Bypass Disabled" is selected, the UPS will switch to no-output mode after a few seconds.

The operating mode can be set to "UPS", "ECO", or "CVF" (where "UPS" indicates normal online mode, "ECO" indicates high-efficiency mode, and "CVF" indicates converter mode). Changes to the operating mode will only take effect after the UPS is turned on.

The external battery pack number can be set from "000" to "009" (where "009" corresponds to nine external battery packs).

The battery remaining time function can be set to "000" or "001" (where "000" disables the battery remaining time display on the LCD during battery mode, and "001" enables it). When enabled, the battery remaining time (in minutes or seconds) and the "bATT" string will alternately display on the LCD every two seconds in battery mode or during a battery test.

- An example of switching the operating mode from Normal Mode to Converter Mode via the LCD display.

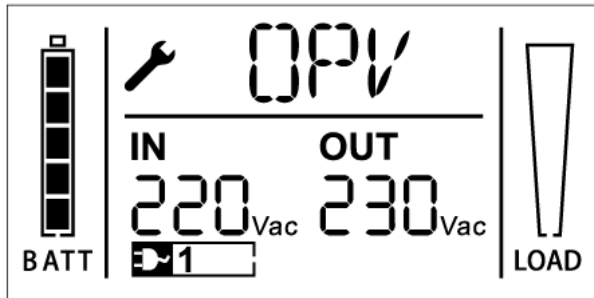

**Step 1:** "OPV" after pressing the "Enter" button.

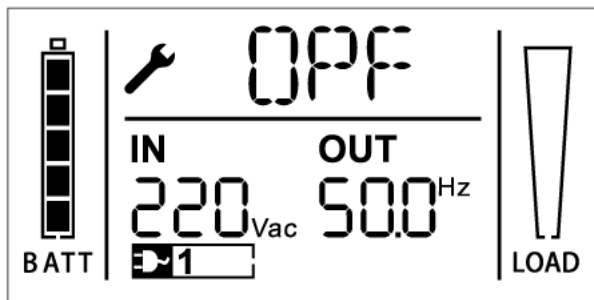

**Step 2:** "OPF" after pressing the "Select" button.

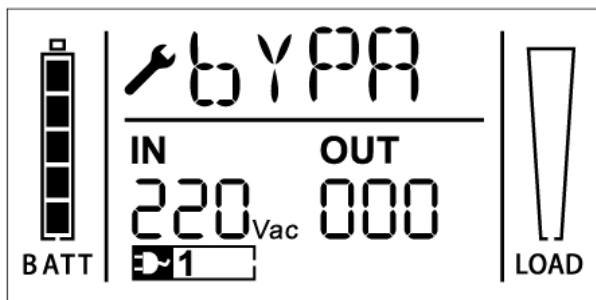

**Step 3:** "bYPA" after pressing the "Select" button.

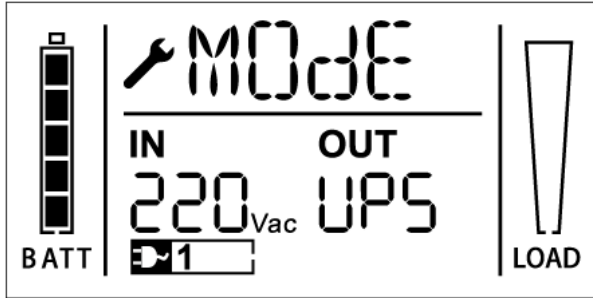

**Step 4:** "MODE" after pressing the "Select" button.  
 "UPS" is flickering after pressing the "Enter" button.

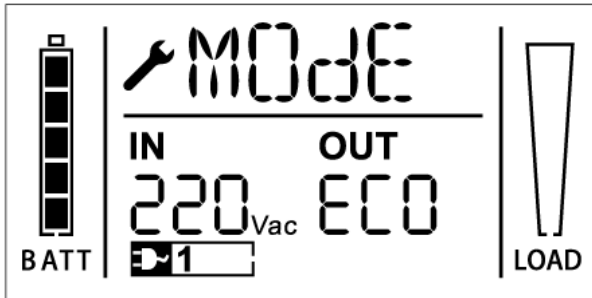

**Step 5:** "ECO" flickering after pressing the "Select" button.

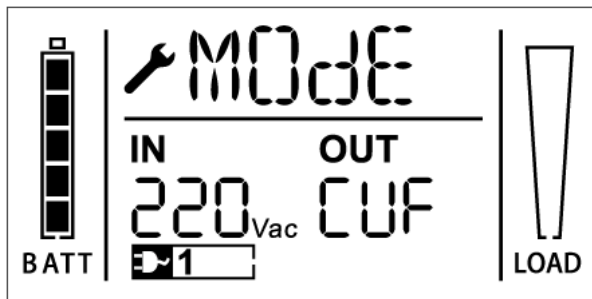

**Step 6:** "CVF" flickering after pressing the "Select" button.  
 Press the "Enter" button  
 Short touch "Enter" button exit setting mode.

## 8. Troubleshooting

If the UPS system does not function correctly, check the operating status on the LCD display. The warning code or fault code will be listed in the Warning & Fault Code Table 6.1. If the issue persists, please refer to the table below to attempt to resolve the problem.

Warning & Fault Code	Problem	Possible Cause	Remedy
/	No indication, no warning tone even though system is connected to mains power supply	<ol style="list-style-type: none"> <li>1) No input voltage</li> <li>2) Breaker open</li> </ol>	<ol style="list-style-type: none"> <li>1) Check building wiring socket outlet and input cable.</li> <li>2) Check the Breaker</li> </ol>
/	No Communication data	<ol style="list-style-type: none"> <li>1) RS232 wire is not matched</li> <li>2) USB wire is not matched</li> </ol>	<ol style="list-style-type: none"> <li>1) Check or change the RS232 wire</li> <li>2) Check or change the USB wire</li> </ol>
/	Emergency supply period shorter than nominal value	<ol style="list-style-type: none"> <li>1) Batteries not fully charged</li> <li>2) Batteries defect</li> </ol>	<ol style="list-style-type: none"> <li>1) Charge the batteries until the Batteries are fully charged</li> <li>2) Change the batteries or consult your dealer.</li> </ol>
FANF	Fan fail	Fan abnormal	Check if the fan is running
HIGH	Battery over voltage	Battery is over charged	Switching to battery mode automatically, and

			after the battery voltage is normal and the mains is normal, the UPS would Switch to line mode automatically again.
bLOW	Battery low	Battery voltage is low	When audible alarm sounding every second, battery is almost empty.
bOPN	Battery open	Battery pack is not connected correctly	Do the battery test to confirm. Check the battery bank is connected to the UPS. Check the battery breaker is turn on.
CHGF	Charge fail	The charge is broken	Notify dealer
dCHF	Digital bigger charger fail	The charge is broken	Notify dealer
bUSH	Bus high	UPS internal fault	Notify dealer
bUSL	Bus low	UPS internal fault	Notify dealer
bSFT	Bus soft start fail	UPS internal fault	Notify dealer
bUSS	Bus short	UPS internal fault	Notify dealer
TEPH	Inverter temperature high	Inside temperature of the UPS is too high	Check the ventilation of the UPS, check the ambient temperature.

ITPH	Inner Ambient temperature high	The ambient temperature is too high	Check the environment ventilation.
INVH	Inverter high	UPS internal fault	Notify dealer
INVL	Inverter low	UPS internal fault	Notify dealer
ISFT	Inverter soft start fail	UPS internal fault	Notify dealer
NTCO	Inverter NTC open	UPS internal fault	Notify dealer
SHOR	Inverter short	Output short circuit	Remove all the loads. Turn off the UPS. Check whether the output of UPS and loads is short circuit. Make sure the short circuit is removed, and the UPS has no internal faults before turning on again.
OVTP	Over temperature fault	Over temperature	Check the ventilation of the UPS, check the ambient temperature and ventilation.
OVLD	Overload	Overload	Check the loads and remove some non-critical loads. Check whether some loads are failed.
SITE	Site fail	Phase and neutral conductor at input of UPS system are reversed	Rotate mains power socket by 180° or connect UPS system.



EPO	EPO active	EPO function is enabled	Plug into the EPO switch.
-----	------------	-------------------------	---------------------------

Please ensure you have the following information ready before contacting the After-Sales Service Department:

1. **Model Number and Serial Number**
2. **Date of Issue:** The date when the problem occurred
3. **System Status:** LCD display status and buzzer alarm status
4. **Power and Load Details:** Mains power condition, load type and capacity, environmental temperature, and ventilation condition
5. **Battery Information:** Details of the external battery pack, including battery capacity and quantity
6. **Additional Problem Details:** Any other relevant information to provide a complete description of the issue

Having this information will help facilitate a faster and more efficient resolution of your problem.

## 9. Maintenance

### 9.1 Operation

The UPS system does not contain any user-serviceable parts.

### 9.2 Storage

If the batteries are stored in temperate climate zones, it is recommended to recharge them every three months for 1–2 hours. In locations exposed to high temperatures, it is strongly advised to reduce the recharging interval to every two months.

## Special Instruction

- **UPS Enclosure IP Rating:** IP20
- **Protective Class:** I
- **Certification Standards:**
- Safety: IEC/EN 62040-1
- EMC: IEC/EN 62040-2
- Performance: IEC/EN 62040-3

### **Output Short-Circuit Current:**

- Maximum RMS Current and Delay Time: 40A / 70ms
- Maximum Peak Value: 76A

### **Compatible Power Systems:**

This UPS is suitable for and can supply loads in TN/TT power systems.

### **Battery Grounding Safety:**

- Ensure the battery is not inadvertently grounded.
- If the battery is inadvertently grounded, disconnect the source from the ground.
- Contact with any part of a grounded battery may result in electrical shock.
- To reduce the risk of electrical shock, ensure such grounds are removed during installation and maintenance.

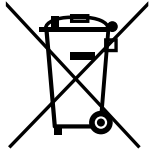

The crossed-out wheeled bin symbol indicates that waste electrical and electronic equipment should not be discarded together with unseparated household waste but must be collected separately. The product should be handed in for recycling in accordance with the local environmental regulations for waste disposal.

By separating waste electrical and electronic equipment, you will help reduce the volume of waste sent for incineration or land-fills and minimize any potential negative impact on human health and environment.

---

# 10. Technical Data

## 10.1 Electrical Specifications

INPUT	
Model No.	Maxima Online 3kVA
Phase	Single
Frequency	40~70 Hz

OUTPUT	
Model No.	Maxima Online 3kVA
Power rating*	3kVA/2.7kW
Voltage	220Vac/230Vac/240Vac
Frequency	50/60Hz
Wave form	Sinusoidal

**\*Note:** *The active power is defined in rated voltage input*

BATTERIES	
Model No.	Maxima Online 3kVA
Voltage	72V
Capacity	9Ah

**\*Note:**

- 1. The Capacity of external batteries can be set to 300Ah maximum, but it may need more time to fully charge the batteries.*
- 2. For Maxima 3 kVA with EBM connector models, the capacity is 9Ah~120Ah\*.*

## 10.2 Operating Environment

Ambient Temperature	0 oC to 40 oC
Operating humidity	< 95%
Altitude	< 1000m (Note 1)
	1000m< Altitude≤3000m (Note 2)
Storage temperature	-25°C~55°C

**Note 1: The load no derating**

**Note 2: The load should derating 1 % for every up 100m**

## 10.3 Dimensions and Weights

Model No.	Dimensions W×H×D (mm)	Net Weight (kg)
Maxima Online 3kVA	190*327*399	22.7kg

Product Code	Product Description
97617302	Maxima Online 3kVA 1Ph 220V 6x12V9Ah

## **11. Communication Port**

On the rear panel of the UPS (see Appendix), USB connector is standard, RS232 connector and Slot for optional connectivity cards are optional.

### **11.1 USB and RS-232 (Optional) Communication Ports**

To establish communication between the UPS and a computer, use an appropriate communication cable.

### **11.2 USB for HID power device**

The USB interface includes a "smart battery" feature that supports the HID (Human Interface Device) Power Device Class, eliminating the need for additional software installation. Operating systems such as Windows, Linux, and Mac OS have built-in power management and monitoring functions. When a computer is connected to the UPS via a USB cable, the operating system automatically recognizes the UPS as a "HID UPS Battery." Users can configure alarm actions, such as automatic shutdown, in the event of a low battery. This feature makes the UPS especially suitable as a backup power solution for NAS (Network-Attached Storage) devices.

### **11.3 AS400 Interface (Optional)**

The UPS is equipped with isolated dry contact relay outputs to indicate various statuses, such as Mains/Utility Failure, Low Battery, UPS Alarm/OK, On Bypass, and more. For detailed information about the interface definitions, please refer to the AS400 user manual.

### **11.4 CMC Interface (Optional)**

The UPS supports connection to the Modbus protocol via a standard RS485 signal. For more detailed information, please refer to the CMC user manual.

## 11.5 NMC Interface (Optional)

The NMC (Network Management Card) enables the UPS to communicate across various networking environments and with different types of devices. It facilitates remote management of the UPS via the internet or intranet. For more information, please contact your local dealer. Detailed instructions can be found in the NMC user manual.

## 12. Software

### Free Software Download – WinPower

WinPower is brand new UPS monitoring software, which provides user-friendly interface to monitor and control your UPS. This unique software provides safely auto shutdown for multi-computer systems while power failure. With this software, users can monitor and control any UPS on the same LAN no matter how far from the UPSs.

### Installation procedure:

1. Go to the website:  
<http://www.ups-software-download.com/winpower.htm>
2. Choose the operation system you need and follow the instruction described on the website to download the software.
3. When downloading all required files from the internet, enter the serial No: **511C1-01220-0100-478DF2A** to install the software.

When your computer restarts, the WinPower software will appear as a green plug icon located in the system tray, near the clock.

**Contact Sollatek if you have any questions.**  
[support@sollatek.com](mailto:support@sollatek.com)

# Appendix: Rear Panel

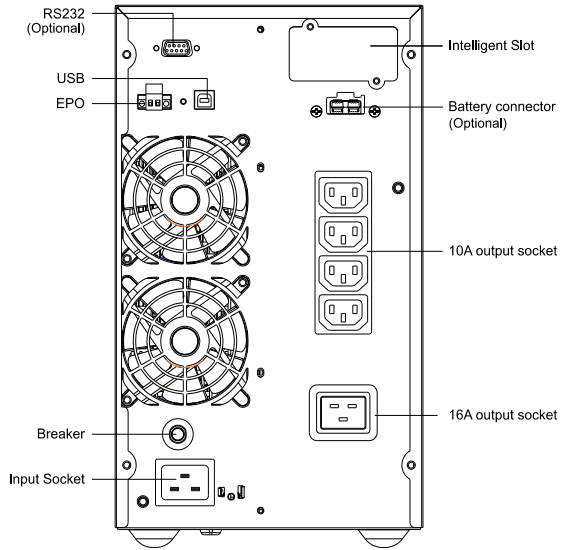

Maxima Online 3kVA  
Back View





---

**SOLLATEK (UK) LIMITED**

Sollatek House, Waterside Drive, Langley, Slough  
SL3 6EZ, United Kingdom

Tel: +44 (1753) 214 500  
Email: [sales@sollatek.com](mailto:sales@sollatek.com)  
Web: [www.sollatek.com](http://www.sollatek.com)